

8MHz, Precision, JFET Input Operational Amplifier

The Intersil HA-5170 is a precision, JFET input, operational amplifier which features low noise, low offset voltage and low offset voltage drift. Constructed using FET/Bipolar technology, the Intersil Dielectric Isolation (DI) process, and laser trimming this amplifier offers low input bias and offset currents. This operational amplifier design also completely eliminates the troublesome errors due to warm-up drift.

Complementing these excellent input characteristics are dynamic performance characteristics never before available from precision operational amplifiers. An 8V/μs slew rate and 8MHz bandwidth allow the designer to extend precision instrumentation applications in both speed and bandwidth. These characteristics make the HA-5170 well suited for precision integrator amplifier designs.

The superior input characteristics also make the HA-5170 ideally suited for transducer signal amplifiers, precision voltage followers and precision data acquisition systems. For application assistance, please refer to Application Note AN540 addressing specifically this device.

Pinout

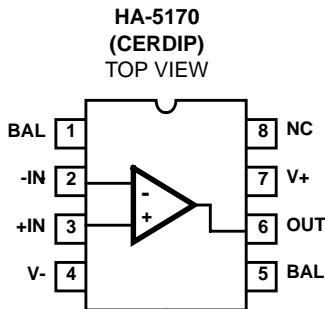

Features

- Low Offset Voltage 100μV
- Low Offset Voltage Drift 2μV/°C
- Low Noise 10nV/√Hz
- High Open Loop Gain. 600kV/V
- Wide Bandwidth 8MHz
- Unity Gain Stable

Applications

- High Gain Instrumentation Amplifiers
- Precision Data Acquisition
- Precision Integrators
- Precision Threshold Detectors
- For Further Design Ideas, Refer to Application Note 540

Ordering Information

PART NUMBER	TEMP. RANGE (°C)	PACKAGE	PKG. NO.
HA7-5170-5	0 to 75	8 Ld CERDIP	F8.3A

HA-5170

Absolute Maximum Ratings

Voltage Between V+ and V- Terminals 44V
 Differential Input Voltage 30V
 Output Short Circuit Duration Indefinite

Operating Conditions

Temperature Range
 HA-5170-5 0°C to 75°C

Thermal Information

Thermal Resistance (Typical, Note 1) θ_{JA} (°C/W) θ_{JC} (°C/W)
 CERDIP Package 115 28
 Maximum Junction Temperature 175°C
 Maximum Storage Temperature Range -65°C to 150°C
 Maximum Lead Temperature (Soldering 10s) 300°C

CAUTION: Stresses above those listed in "Absolute Maximum Ratings" may cause permanent damage to the device. This is a stress only rating and operation of the device at these or any other conditions above those indicated in the operational sections of this specification is not implied.

NOTE:

- θ_{JA} is measured with the component mounted on a low effective thermal conductivity test board in free air. See Tech Brief TB379 for details.

Electrical Specifications $V_{SUPPLY} = \pm 15V$, Unless Otherwise Specified

PARAMETER	TEST CONDITIONS	TEMP. (°C)	HA-5170-5			UNITS
			MIN	TYP	MAX	
INPUT CHARACTERISTICS						
Offset Voltage		25	-	0.1	0.3	mV
		Full	-	-	0.5	mV
Average Offset Voltage Drift (Note 3)		Full	-	2	5	$\mu V/^\circ C$
Bias Current		25	-	20	100	pA
		Full	-	0.1	2	nA
Bias Current Average Drift		Full	-	3	-	$pA/^\circ C$
Offset Current		25	-	3	60	pA
		Full	-	-	0.1	nA
Offset Current Average Drift (Note 3)		Full	-	0.3	1	$pA/^\circ C$
Common Mode Range		Full	± 10	+15.1	-	V
		Full	-	-12	-	V
Differential Input Capacitance		25	-	80	100	pF
Differential Input Resistance (Note 3)		25	1×10^{10}	6×10^{10}	-	Ω
Input Capacitance (Single Ended)		25	-	12	-	pF
Input Noise Voltage (Note 3)	0.1Hz to 10Hz	25	-	0.5	5	μV_{P-P}
Input Noise Voltage Density (Note 3)	f = 10Hz	25	-	20	150	nV/\sqrt{Hz}
	f = 100Hz	25	-	12	50	nV/\sqrt{Hz}
	f = 1000Hz	25	-	10	25	nV/\sqrt{Hz}
Input Noise Current Density (Note 3)	f = 10Hz	25	-	0.05	-	pA/\sqrt{Hz}
	f = 100Hz	25	-	0.01	-	pA/\sqrt{Hz}
	f = 1000Hz	25	-	0.01	0.1	pA/\sqrt{Hz}

HA-5170

Electrical Specifications $V_{SUPPLY} = \pm 15V$, Unless Otherwise Specified (Continued)

PARAMETER	TEST CONDITIONS	TEMP. (°C)	HA-5170-5			UNITS
			MIN	TYP	MAX	
TRANSFER CHARACTERISTICS						
Large Signal Voltage Gain	$V_{OUT} = \pm 10V$, $R_L = 2k\Omega$	25	300	600	-	kV/V
		Full	250	-	-	kV/V
Common Mode Rejection Ratio	$\Delta V_{CM} = \pm 10V$	Full	90	100	-	dB
Minimum Stable Gain		25	1	-	-	V/V
Closed Loop Bandwidth	$A_{VCL} = +1$	25	4	8	-	MHz
OUTPUT CHARACTERISTICS						
Output Voltage Swing	$R_L = 2k\Omega$	25	± 10	± 12	-	V
Full Power Bandwidth (Note 4)	$R_L = 2k\Omega$	25	80	120	-	kHz
Output Current (Note 5)	$V_{OUT} = \pm 10V$	25	± 10	± 15	-	mA
Output Resistance (Note 3)	Open Loop, 100Hz	25	-	45	100	Ω
TRANSIENT RESPONSE						
Rise Time	Note 2	25	-	45	100	ns
Slew Rate	Note 2	25	5	8	-	V/ μs
Settling Time (Notes 3, 6)		25	-	1	5	μs
POWER SUPPLY CHARACTERISTICS						
Supply Current		Full	-	1.9	2.5	mA
Power Supply Rejection Ratio (Note 7)		Full	90	105	-	dB

NOTES:

- See "Test Circuits and Waveforms" section.
- Parameter is not 100% tested. 90% of all units meet or exceed these specifications.
- Full power bandwidth guaranteed based on slew rate measurement using: $FPBW = \frac{\text{Slew Rate}}{2\pi V_{PEAK}}$.
- I_{SC} turns on at $\approx 23mA$.
- Settling time is measured to 0.1% of final value for a 10V output step and $A_V = -1$.
- $V_+ = +15V$, $V_- = -10V$ to $-20V$ and $V_- = -15V$, $V_+ = +10V$ to $+20V$.

Test Circuits and Waveforms

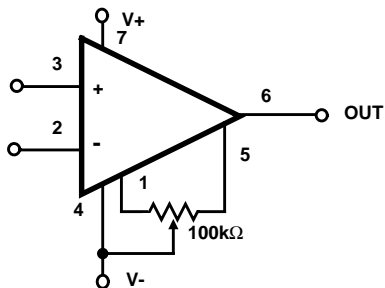

Tested Offset Adjustment Range is $|V_{OS} + 1mV|$ minimum referred to output. Typical range is $\pm 5mV$ with $R_T = 1k\Omega$ and $\pm 15mV$ with $R_T = 100k\Omega$.

FIGURE 1. V_{OS} ADJUSTMENT

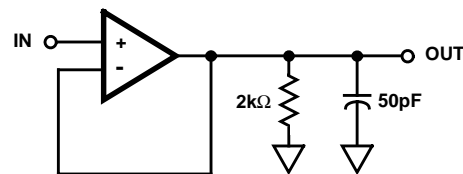
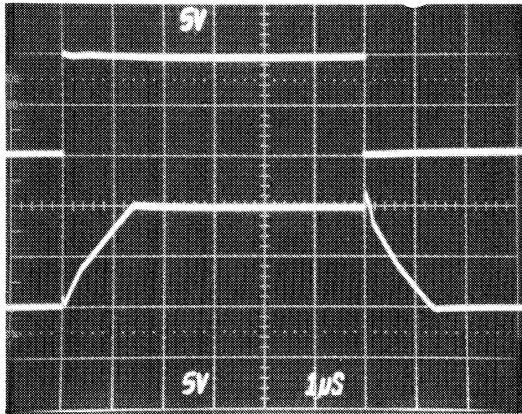

FIGURE 2. LARGE AND SMALL SIGNAL RESPONSE CIRCUIT

Test Circuits and Waveforms (Continued)



Vertical Scale: 5V/Div.
Horizontal Scale: 1µs/Div.

LARGE SIGNAL RESPONSE

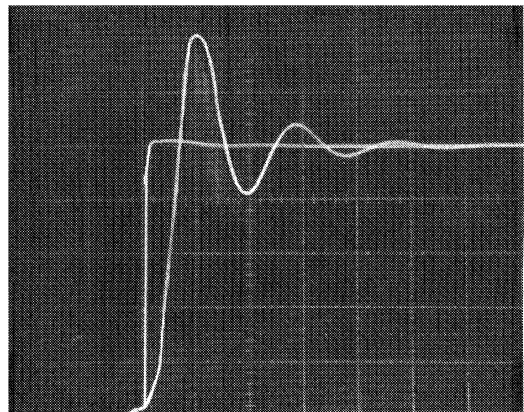

Vertical Scale: 10mV/Div.
Horizontal Scale: 100ns/Div.

SMALL SIGNAL RESPONSE

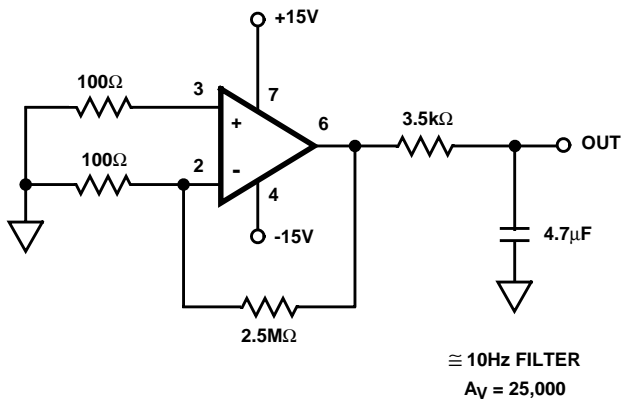
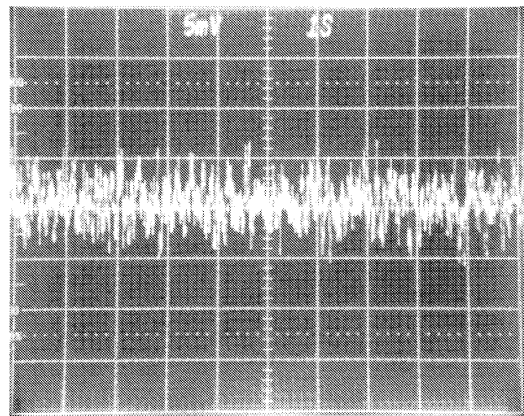

FIGURE 3. LOW FREQUENCY NOISE TEST CIRCUIT



Vertical Scale: 200nV/Div. (Noise Referred to Input)
5mV/Div. at Output, $A_{VCL} = 25,000$
Horizontal Scale: 1s/Div.

HA-5170 LOW FREQUENCY NOISE (0.1HZ TO 10HZ)

Schematic Diagram

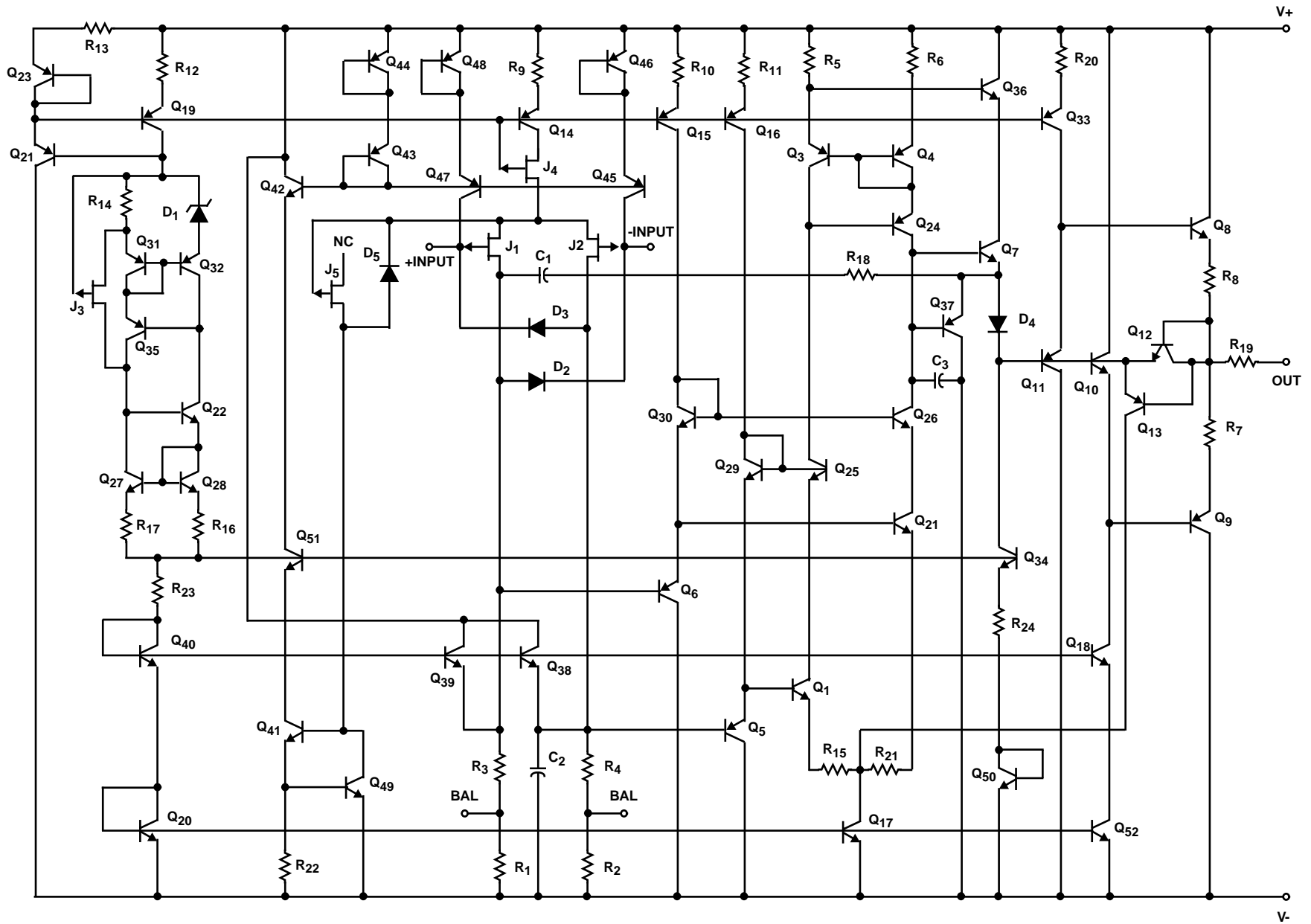

Typical Performance Curves

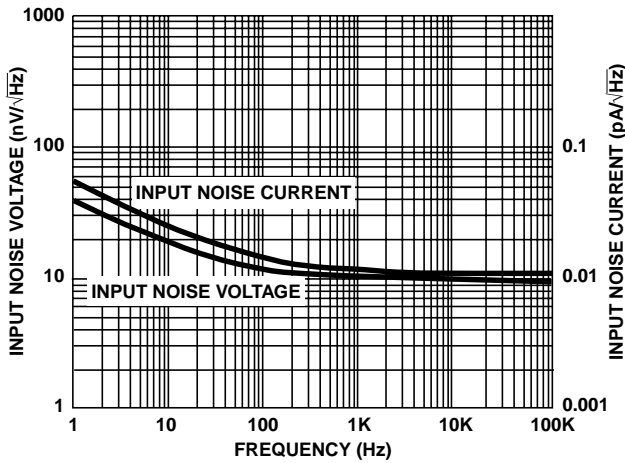

FIGURE 4. INPUT NOISE vs FREQUENCY

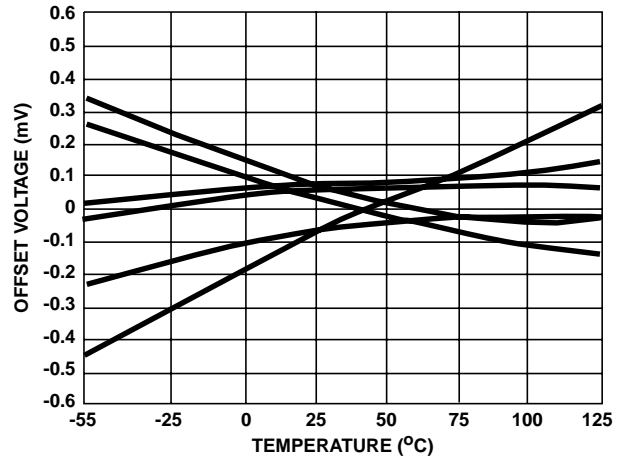

FIGURE 5. OFFSET VOLTAGE DRIFT vs TEMPERATURE OF REPRESENTATIVE UNITS

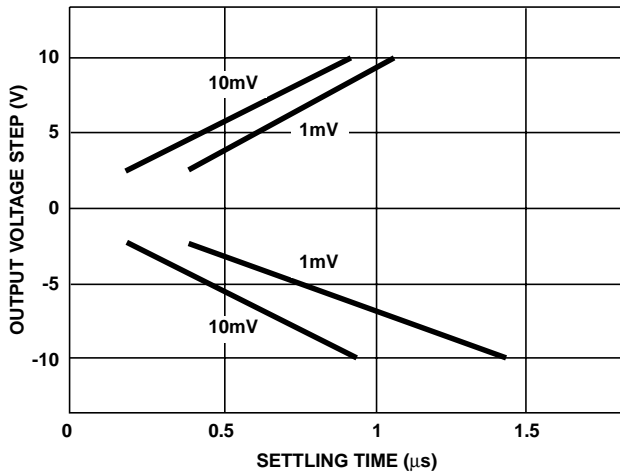

FIGURE 6. SETTLING TIME FOR VARIOUS OUTPUT STEP VOLTAGES

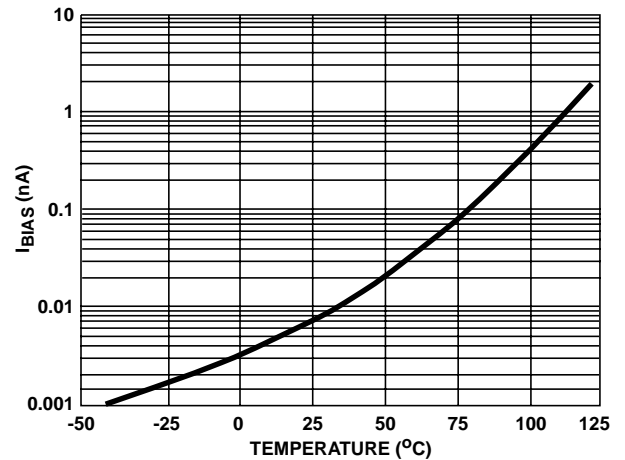

FIGURE 7. BIAS CURRENT vs TEMPERATURE

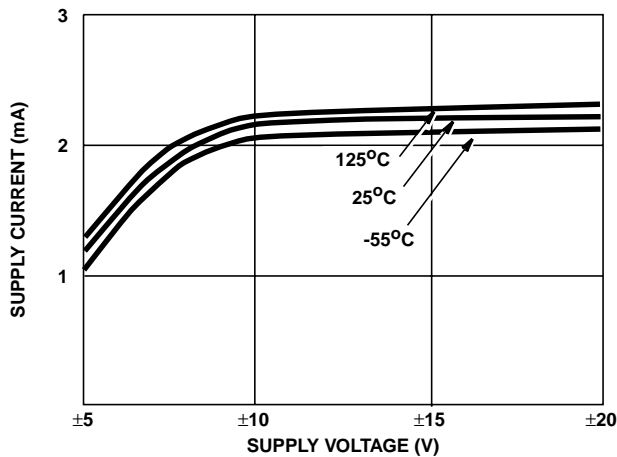

FIGURE 8. POWER SUPPLY CURRENT vs SUPPLY VOLTAGE

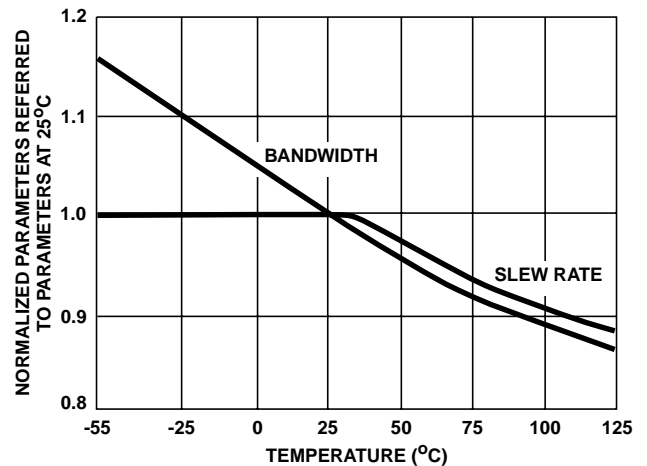

FIGURE 9. NORMALIZED AC PARAMETERS vs TEMPERATURE

Typical Performance Curves (Continued)

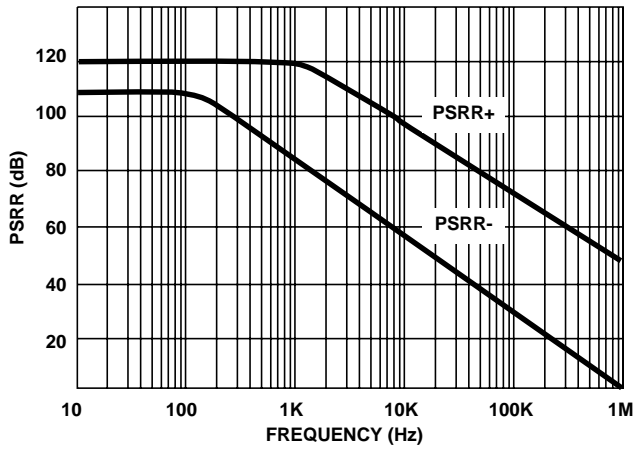

FIGURE 10. POWER SUPPLY REJECTION RATIO vs FREQUENCY

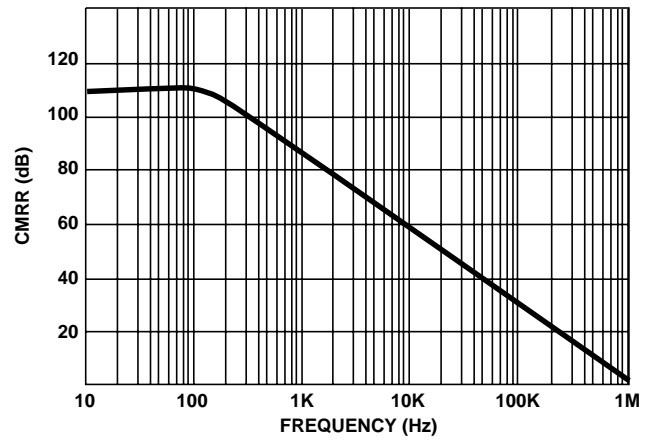

FIGURE 11. COMMON MODE REJECTION RATIO vs FREQUENCY

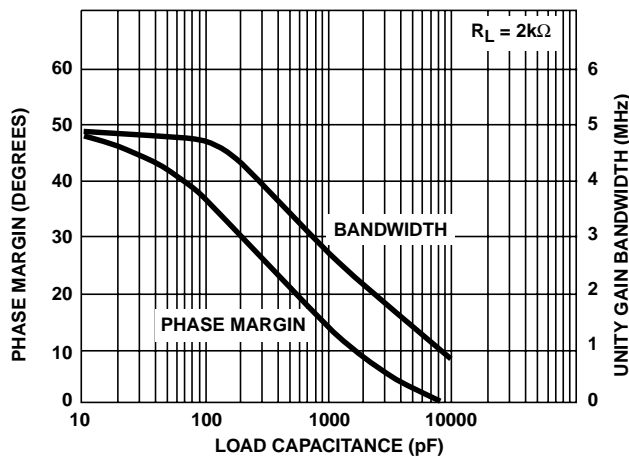

FIGURE 12. SMALL SIGNAL BANDWIDTH AND PHASE MARGIN vs LOAD CAPACITANCE

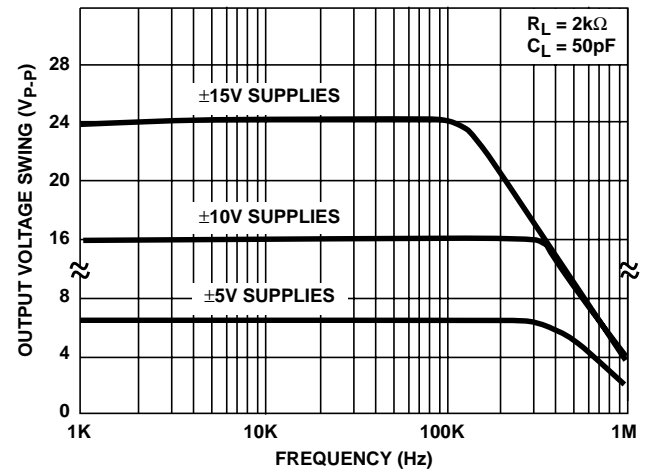

FIGURE 13. OUTPUT VOLTAGE SWING vs FREQUENCY AND SUPPLY VOLTAGE

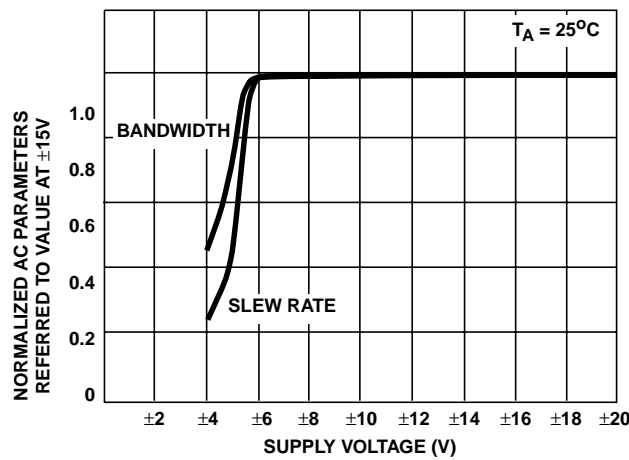

FIGURE 14. NORMALIZED AC PARAMETERS vs SUPPLY VOLTAGE

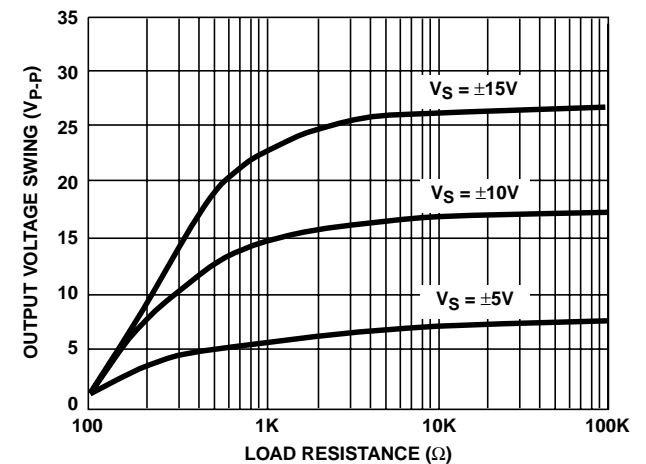

FIGURE 15. MAXIMUM OUTPUT VOLTAGE SWING vs LOAD RESISTANCE

Typical Performace Curves (Continued)

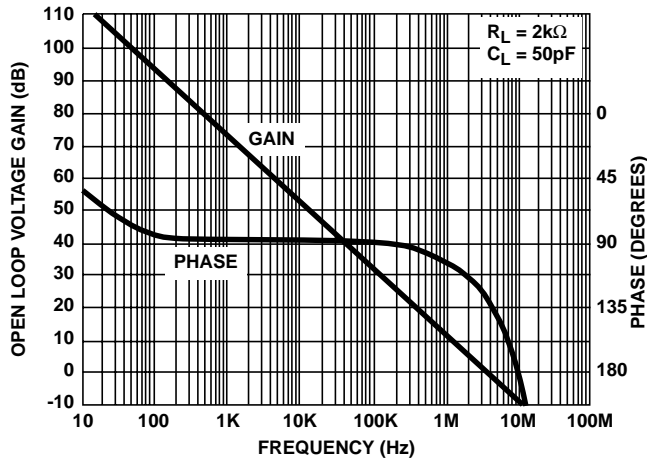

FIGURE 16. OPEN LOOP FREQUENCY RESPONSE

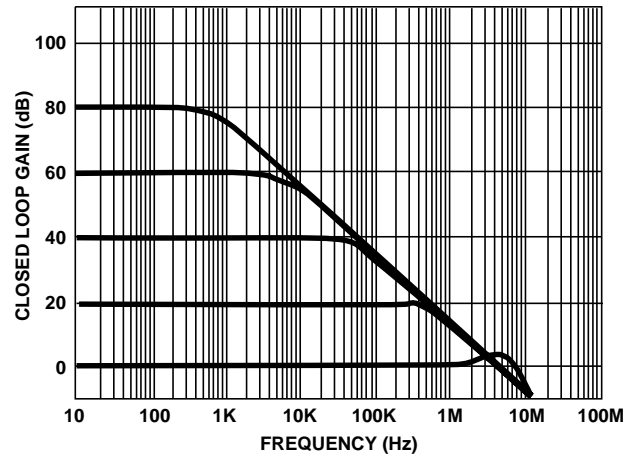
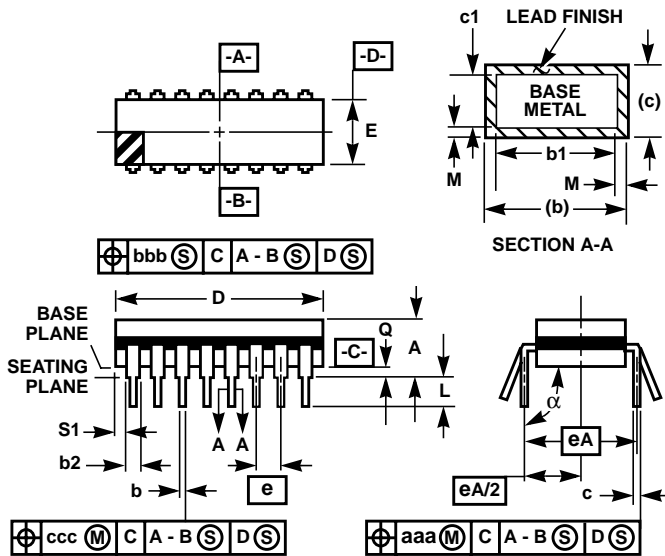

FIGURE 17. CLOSED LOOP FREQUENCY RESPONSE FOR VARIOUS CLOSED LOOP GAINS

Ceramic Dual-In-Line Frit Seal Packages (CERDIP)



**F8.3A MIL-STD-1835 GDIP1-T8 (D-4, CONFIGURATION A)
8 LEAD CERAMIC DUAL-IN-LINE FRIT SEAL PACKAGE**

SYMBOL	INCHES		MILLIMETERS		NOTES
	MIN	MAX	MIN	MAX	
A	-	0.200	-	5.08	-
b	0.014	0.026	0.36	0.66	2
b1	0.014	0.023	0.36	0.58	3
b2	0.045	0.065	1.14	1.65	-
b3	0.023	0.045	0.58	1.14	4
c	0.008	0.018	0.20	0.46	2
c1	0.008	0.015	0.20	0.38	3
D	-	0.405	-	10.29	5
E	0.220	0.310	5.59	7.87	5
e	0.100 BSC		2.54 BSC		-
eA	0.300 BSC		7.62 BSC		-
eA/2	0.150 BSC		3.81 BSC		-
L	0.125	0.200	3.18	5.08	-
Q	0.015	0.060	0.38	1.52	6
S1	0.005	-	0.13	-	7
α	90°	105°	90°	105°	-
aaa	-	0.015	-	0.38	-
bbb	-	0.030	-	0.76	-
ccc	-	0.010	-	0.25	-
M	-	0.0015	-	0.038	2, 3
N	8		8		8

NOTES:

1. Index area: A notch or a pin one identification mark shall be located adjacent to pin one and shall be located within the shaded area shown. The manufacturer's identification shall not be used as a pin one identification mark.
2. The maximum limits of lead dimensions b and c or M shall be measured at the centroid of the finished lead surfaces, when solder dip or tin plate lead finish is applied.
3. Dimensions b1 and c1 apply to lead base metal only. Dimension M applies to lead plating and finish thickness.
4. Corner leads (1, N, N/2, and N/2+1) may be configured with a partial lead paddle. For this configuration dimension b3 replaces dimension b2.
5. This dimension allows for off-center lid, meniscus, and glass overrun.
6. Dimension Q shall be measured from the seating plane to the base plane.
7. Measure dimension S1 at all four corners.
8. N is the maximum number of terminal positions.
9. Dimensioning and tolerancing per ANSI Y14.5M - 1982.
10. Controlling dimension: INCH

Rev. 0 4/94

All Intersil semiconductor products are manufactured, assembled and tested under **ISO9000** quality systems certification.

Intersil semiconductor products are sold by description only. Intersil Corporation reserves the right to make changes in circuit design and/or specifications at any time without notice. Accordingly, the reader is cautioned to verify that data sheets are current before placing orders. Information furnished by Intersil is believed to be accurate and reliable. However, no responsibility is assumed by Intersil or its subsidiaries for its use; nor for any infringements of patents or other rights of third parties which may result from its use. No license is granted by implication or otherwise under any patent or patent rights of Intersil or its subsidiaries.

For information regarding Intersil Corporation and its products, see web site www.intersil.com

Sales Office Headquarters

NORTH AMERICA
Intersil Corporation
P. O. Box 883, Mail Stop 53-204
Melbourne, FL 32902
TEL: (321) 724-7000
FAX: (321) 724-7240

EUROPE
Intersil SA
Mercure Center
100, Rue de la Fusee
1130 Brussels, Belgium
TEL: (32) 2.724.2111
FAX: (32) 2.724.22.05

ASIA
Intersil Ltd.
8F-2, 96, Sec. 1, Chien-kuo North,
Taipei, Taiwan 104
Republic of China
TEL: 886-2-2515-8508
FAX: 886-2-2515-8369